



Technical Application Guide for XT Lighting LED Downlight

WR170-18W

Introduction



XTlighting SMD LED Down light adopts high lumen SMD LED, PMMA diffuser with even light output. White, silver, chrome surface treatments are available for wide choice. Triac dimmable, 0-10V dimmable and DALI dimmable version share great popularity by excellent dimming effect.

- Up to 70% energy saving compared to standard CFL
- Long lifetime of 50,000 hours
- Triac dim, 0-10V dim, DALI dim
- 90° wide beam angle
- 140-150mm cutout
- CCT: 3000K 4000K
5000K 5700K
- No UV/IR light
- Environment friendly, without Mercury or any other hazardous substances

Application notes

- IP20/IP44 for indoor use only
- Professional electrician for installation only
- Switch off before installation
- Do not touch when in use
- Keep away from hot steam and corrosive gas

Application Areas

It is designed for general lighting applications in office, supermarket, shop, school, hotel, etc. It is also widely used for public areas, such as stairway, lobby, reception, corridors etc.

Certificate

CE **RoHS** **SAA**



Product Information

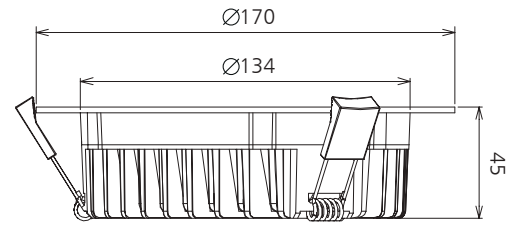

Technical Specifications

Model	Voltage	Power	Power Factor	Lumen (±5%)	CCT	Beam angle	Lifespan	CRI	Dimmable	Dimension
WR170-18W	AC100-240V	18W	≥0.9	1400	3000K	90°	50,000h	≥80	No	Ø170*45mm cutout Ø140-150mm
				1430	4000K					
				1490	5000K					
				1550	5700K					
WR170-18W-D	AC230V	18W	≥0.9	1380	3000K	90°	50,000h	≥80	Yes	Ø170*45mm cutout Ø140-150mm
				1410	4000K					
				1450	5000K					
				1480	5700K					

Driver data Sheet

Driver data	DIM	Non dim
Input rated Voltage	AC230V	AC100-240V
Frequency	50Hz	50/60Hz
Input Voltage	AC200-240V	AC85-265V
Efficiency	≥78%	≥86%
Total load Wattage	18W±1W	18W±1W
Power Factor	≥0.9	≥0.9
Rated input current	≤0.09A	≤0.2A
Full load output Voltage	DC29-33V	DC29-33V
Rated output current	500mA	500mA
Output current range	500mA±5%	500mA±5%
Power tolerance	±5%	±5%
Current output tolerance	±5%	±5%
Dimming range	8%-100%	—
Dimmer	Triac dimmers	—
Short circuit protection	PASS	PASS
Over voltage protection	PASS	PASS
Over temperature protection	PASS	PASS
Withstand voltage	AC3750V	AC3750V

Fixture Compatibility

Rated Wattage	Electrical Classification	Ingress Protection	Operating Temp	Operating Humidity	Storage Temp
18W	II	IP20 / IP44	-20°C~45°C	0~90%	-20°C~65°C

Spectral Distribution

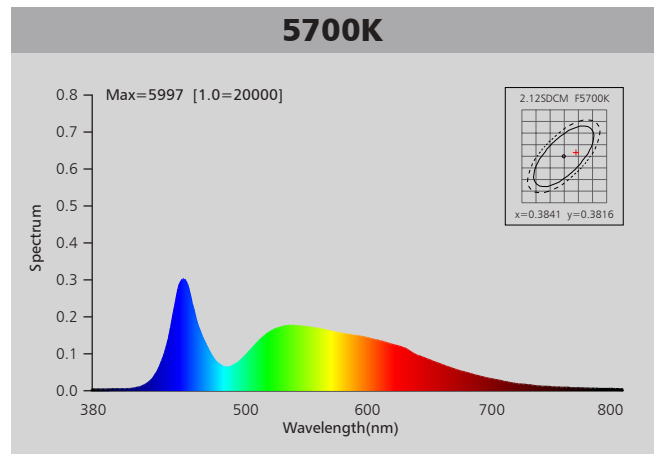
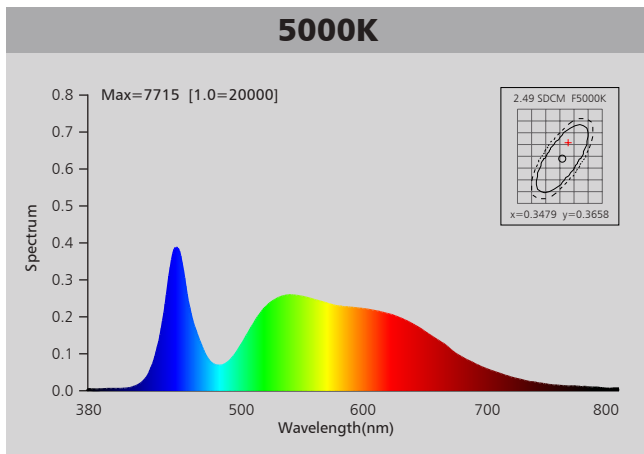
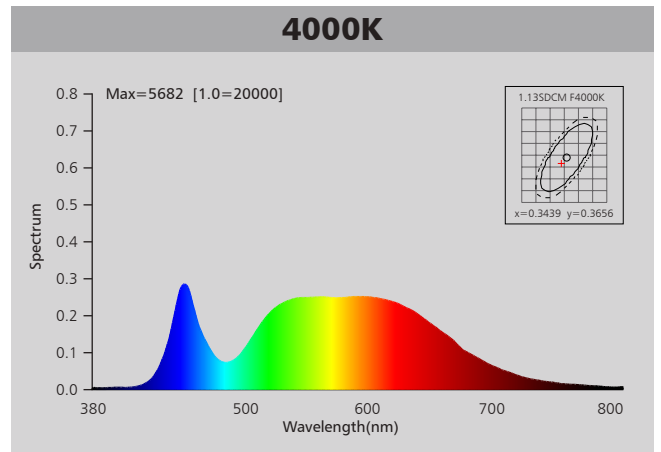
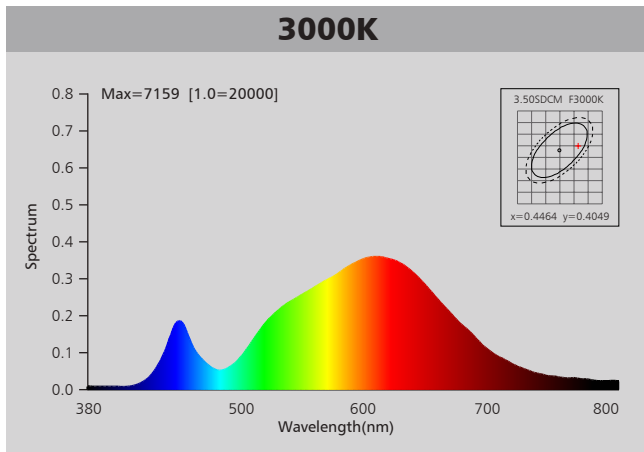

Photometric Diagram

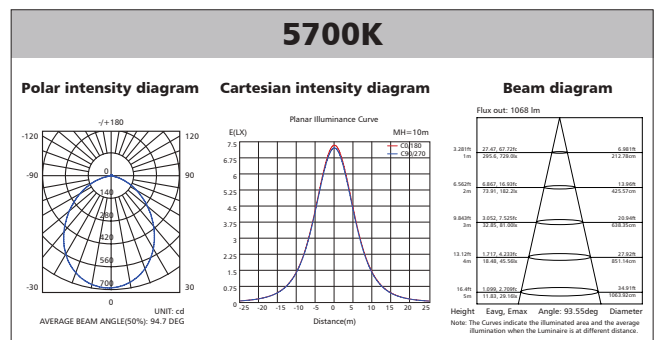
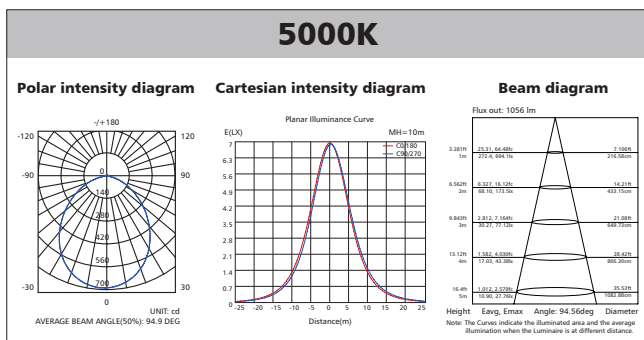
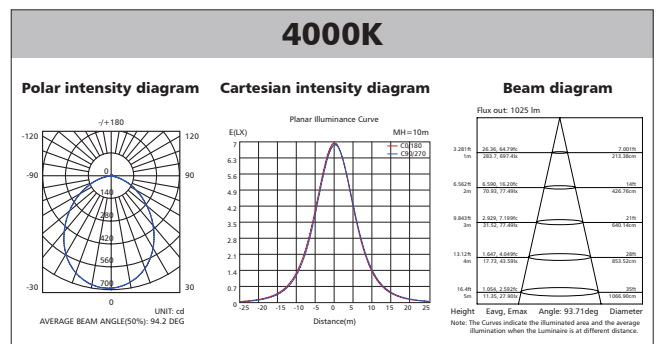
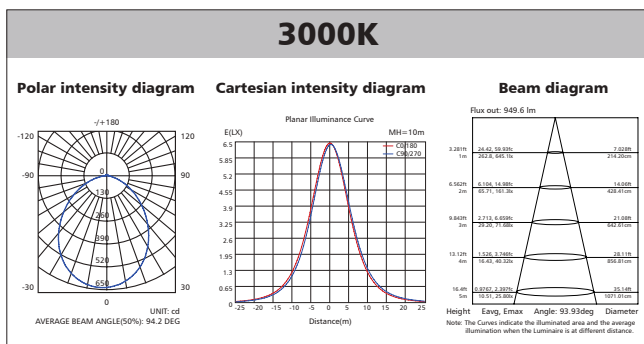

Polar Diagram Comparison

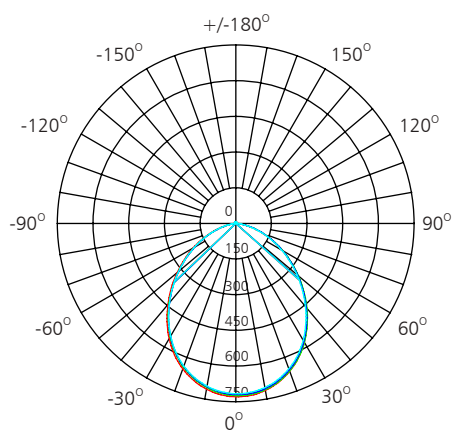

UNIT: cd

- C0/180, 94.8 deg
- C30/210, 94.7 deg
- C60/240, 94.6 deg
- C90/270, 94.6 deg

AVERAGE BEAM ANGLE (50%): 94.7DEG



Driver lifetime & LED light decay rate

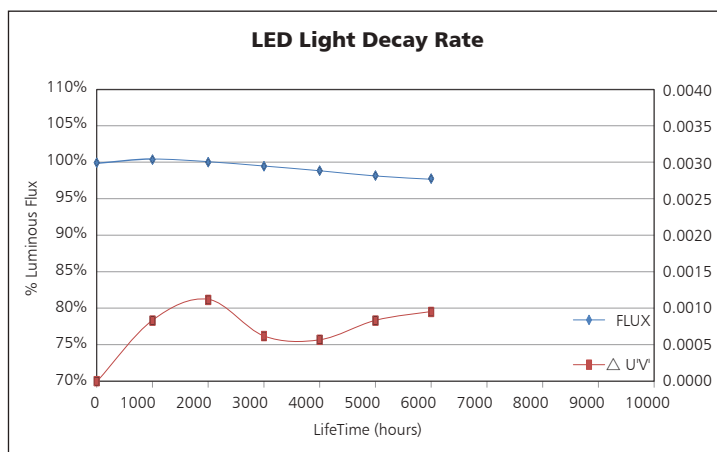
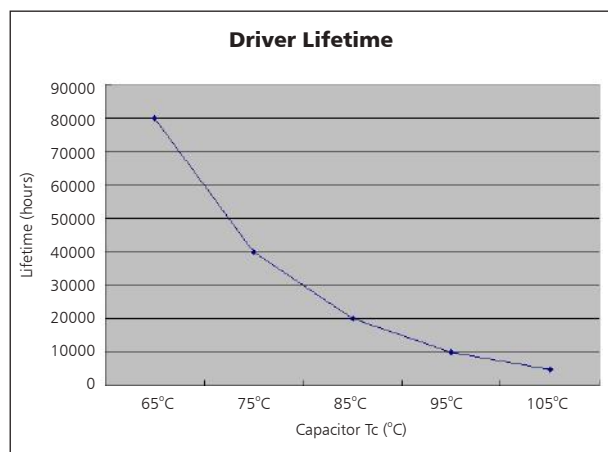

Temperature

- The testing is operated at 25°C
- The lifetime of capacitor, minimum of 5,000 hours if operated at 105°C, will be doubled whenever the temperature drops 10°C
- The highest withstand temperature of IC, MOS could be 120°C
- The highest withstand temperature of LED junction temperature is 150°C

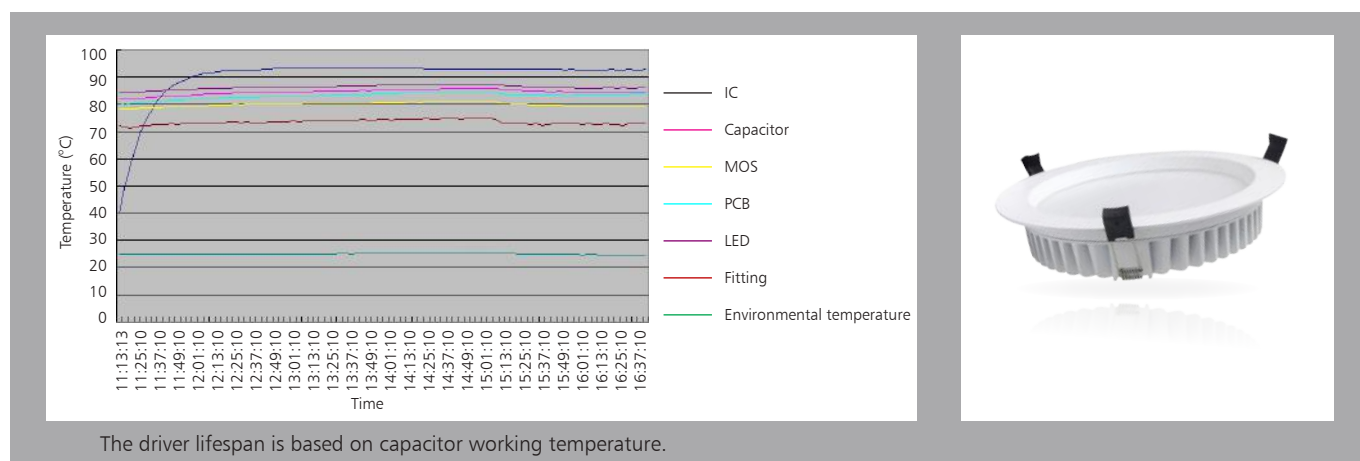

The driver lifespan is based on capacitor working temperature.

Installation

Install requirements	
A-gap above the fitting	25mm
B-gap to the building material	25mm
C-gap to the thermal insulation	25mm

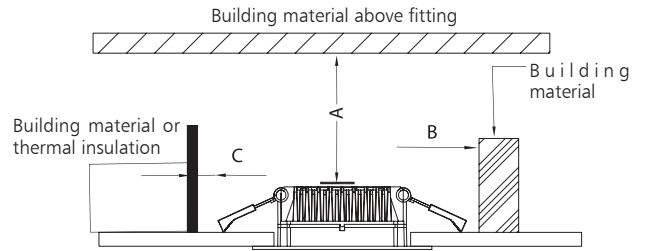

<p>Ceiling Opening Ø140-150mm</p> <p style="text-align: right;">1</p>	<p>Connect Power supply</p> <p style="text-align: right;">2</p>
<p>A. Hold back spring clips</p> <p>B. Push downlight into position</p> <p style="text-align: right;">3</p>	<p>Spring Clips</p> <p style="text-align: right;">4</p>

Packaging Information

	SIZE(CM)	N.W/pc (KGS)	G.W.(KGS)	Q'TY(PCS)
Carton	59 x 40 x 49	0.695	25	30

	CTNS	Q'TY(PCS)	VOLUME(CBM)
20" standard container	230	6900	28
40" standard container	460	13800	56

